

NITECORE®

KEEP INNOVATING

FLS360

360° Illumination Field Lighting System

Features

- 360° Illumination Field Lighting System
- Utilizes CREE XM-L2 LEDs
- Ultra-high output up to 22000 lumens
- A peak beam intensity of 201,200cd and a throw distance up to 897 meters
- Suitable for outdoor, construction site, square or other areas requiring wide range illumination
- Crystal Coating Technology combined with "Precision Digital Optics Technology" for extreme reflector performance
- Integrated high efficient constant circuit provides max runtime of 40 hours
- 4 brightness levels available
- The support includes tripod and telescopic poles
- Max extendable height up to 3.8 meters, meets the demands in various scenarios
- Built-in OLED screen displays brightness levels, battery voltage, runtime and more
- Aerospace aluminum alloy

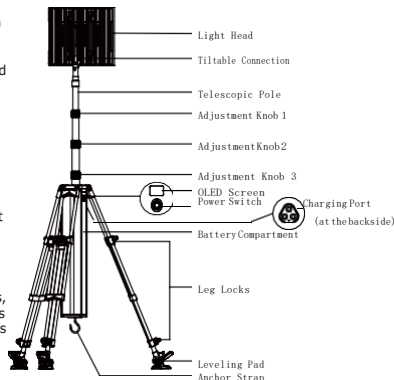

Accessories

AC adaptor, high quality and portable nylon bag, 3×diffuser lens

Specifications

Dimensions	φ0.22m (0.72ft) x 1.02m (3.35ft)		Height	MAX	3.8m (12.47ft)
Weight	13kg (28.66lbs)			MIN	1.02m (3.35ft)
Brightness	Turbo	200W	Battery life	Turbo	3h
	High	75W		High	8h
	Middle	33W		Middle	18h
	Low	15W		Low	40h
Battery capacity	600Wh (48×18650 Li-ion, 3400mAh)		Battery voltage	11.1V	
Charging time	8h		FLS360 rating	IP66	
charger	AC input 100 ~ 240V DC output 15V/19A		Charger rating	IP67	

NOTE: The data may vary in real-world use due to different environmental conditions.

Deploying the FLS360

1. Set the FLS360 down vertically on a flat surface, and open the nylon bag as shown in diagram (1).

2. Adjust the light head which is constructed by 3 light panels. The light panels are flexible and adjustable (for directional or 360° configuration) as shown in diagram (2). The angle can be adjusted by the Tilttable Connection as shown in diagram (3).

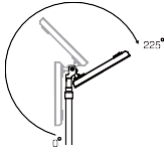

(3)

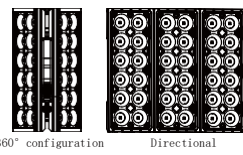

(2)

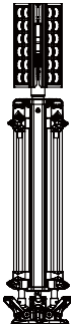

(1)

3. Then, based on preference or need, mount the diffuser lens to the light panels through magnetic absorption.

4. Unfold the tripod, there is an Leg Lock on both ends of each tripod. Extend the tripod based on preference by loosening the Leg Locks in anti-clockwise direction, and when the desired length is displayed, screw the Leg Locks clockwise. After unfolding, use the tent peg to fix the FLS360 on the ground as shown in diagram (4) and (5). There is a detachable Leveling Pad on the end of each leg, which can be adjusted according to the terrain. After disassembly, one can plug the pipe into the sand or the ground of soft soil as shown in diagram (6).

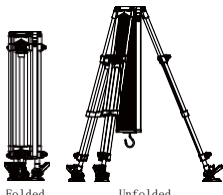

(4)

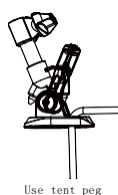

Use tent peg
(5)

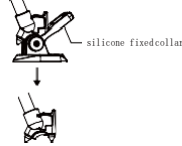

(6)

(Pull up the silicone fixed collar and remove the pipe.)

5. Adjust the telescopic pole. There are 3 Adjustment Knobs on the telescopic pole, loosen Knob 1 counter-clockwise to extend the pole and tighten the knob clockwise. To extend further, loosen the Knob 2 and Knob 3 successively, and then tighten them.

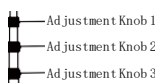

6. An anchor strap is below the battery compartment. In case of heavy wind, attach a sand bag (or equivalent weight under 5kg) to the anchor strap to reinforce stability.

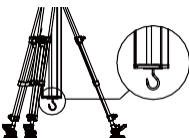

ON/OFF

Turn on: When the FLS360 is off, tap the power switch to enter low mode. At this time, the OLED screen displays the current mode and output, after about 2 seconds, it will display the battery voltage, runtime and remaining power level. The blue power indicator will lit.

Turn off: When the FLS360 is on, press and hold the power switch to turn off the light. At this time, the OLED screen displays battery voltage and remaining power level and then goes out after about 10 seconds. The blue power indicator will blink slowly.

Warning:

1. Application temperature: -20°C ~60°C , when the temperature of the operating environment is below -20°C , please place it in a normal temperature environment for half an hour before use.
2. When the FLS360 is on, the light head will generate heat. Please keep at least 0.5 meter away from it.
3. When the FLS360 is used for extended periods of time, DO NOT touch the light head in case of scalding. After use, MUST wait for cooling down before storing.
4. Avoid direct eye exposure.
5. Children under 18 years old must be supervised by an adult when using the FLS360.

Adjusting Brightness

The FLS360 will enter the Low mode when it is turned on, tap the power switch repeatedly to cycle through "Low-Mid-High-Turbo".

Lockout and Unlock

When the light is off, press and hold the power switch for over 2 seconds to lockout, and the blue indicator will go out. In lockout status, it prevents accidental activation and hardly consumes power. If the power switch is tapped while in lockout, the blue indicator will illuminate and go out after 2 seconds. To unlock, press and hold the power switch for over 2 seconds.

Charging

- Insert one end of AC adaptor into the charging port and the other end into a power socket (dedicated car adaptors is optional).
- When the FLS360 is turned off while charging, the maximum charging current is 10A.
- When the FLS360 is turned on while charging, the charging current is 3A.
- If charging via a car adaptor, the charging current is 3A. If using the light while charging, Turbo and High are not accessible.

NOTE: One must start the car before charging the FLS360 via a car adaptor.

Charging Tips

Charging	Indicator	OLED screen	
		Battery Voltage	Power Level
Charging completed	Constant on	Battery Voltage	Full Power Level
ERROR	Fast blink	ERROR	

NOTE:

1. When the FLS360 is switched off while charging, it takes about 8 hours to refill the battery. (it may vary due to different environments and battery health status)
2. Please recharge the battery in the temperature between 0°C ~45°C.

Protection

- The built-in battery has protective circuit to prevent the battery from overcharging, over-discharging, over current and short circuit.
- When the battery voltage is low, the FLS360 automatically lowers its output to protect battery.
- If one light panel turns off due to malfunction in Turbo mode, the FLS360 will automatically lower its output to High Mode; if two light panels turns off due to malfunction in Turbo or High mode, the FLS360 will automatically lower its output to Middle Mode.

Storing the FLS360

- Turn off the FLS360.
- After the FLS360 is turned off, please wait for 10-20 minutes and fold until the temperature of the light heads drops in case of scalding.
- Retract the telescopic pole. Hold the pole above the Adjustment Knob 3 and then loosen it, retract the poles and then tighten the Adjustment Knob 3. Adjust the length of other poles via the Adjustment Knob 2 and Knob 1 by the same way.
- Put the light heads back into the Stored Position. Adjust the light heads to 0° as shown in diagram (3); Adjust 3 light panels to 360° configuration.
- Fold the tripod. Pull out the tent peg, hold the tripod and loosen the Adjustment Knob of the tripod. Retract the tripod and then tighten and fold the tripod.
- Put it into the nylon portable bag.

Maintenance

1. If the FLS360 is stored for a long time, charge it for 5 hours semiannually.
2. Keep the light head clean for fear that affecting the heat dissipation of the light panels and light transmittance of the lens.
3. Regularly check the Tilttable Connection between the light head and telescopic poles, if it is too loose, use wrench to screw up the spindle nut.

Caution

1. Watch your hands when folding the light heads, telescopic poles and tripod.
2. The FLS360 is high after it is deployed, please assess the use environment and take protection measures to avoid roll over.
3. The Tilttable Connection between the light head and the telescopic poles is fragile, please focus on the support part when carrying and DO NOT catch the light head only.
4. Lockout the FLS360 by long pressing the switch before storing it to avoid accidental activation.
5. It can be used in raining or even rainstorm environments.
6. DO NOT immerse the part above battery compartment into water.

Warranty Service

All NITECORE® products are warranted for quality. All defective / malfunctioning NITECORE® products will be repaired free of charge for a period of 12 months from the date of purchase. After 12 months, a limited warranty applies, covering the cost of labor and maintenance, but not the cost of accessories or replacement parts. The warranty is nullified in all of the following situations:

1. The product(s) is/are broken down, reconstructed and/or modified by unauthorized parties.
2. The product(s) is/are damaged through improper use.

For the latest information on NITECORE® products and services, please contact your national NITECORE® distributor or send an email to service@nitecore.com

※ The Nitecore official website shall prevail in case of any product data changes.

SYSMAX Inc.

SYSMAX Industry Co., Ltd.
TEL: +86-20-83862000
FAX: +86-20-83882723
E-mail: info@nitecore.com
Web: www.nitecore.com
Address: Rm 2601-06, Central Tower, No.5 Xiancun Road, Tianhe District, Guangzhou, 510623, Guangdong, China

Please find us on facebook: Nitecore Flashlight



20170913

Thanks for purchasing NITECORE!

NITECORE® 奈特科尔

FLS360 移动照明系统

产品特性

- 360°全方位户外移动照明系统
- 采用 CREE XM-L2 LED
- 最高 22000 流明超强亮度输出
- 最大光强 201200 坎德拉，最远射程 897 米
- 适用于户外、工地、广场等大范围照明场所
- 采用数字精确优化技术制造的光学系统
- 采用高效率恒流电路，最长 40 小时续航时间
- 设有 4 档亮度可选
- 支架采用三脚架及伸缩杆设计
- 可伸展至 3.8 米高，满足用户在不同场所的使用需求
- 内置 OLED 显示屏，可实时显示亮度、电池电压、续航时间等信息
- 航太级铝合金制造

配件

AC 充电器、优质尼龙便携袋、3× 柔光片

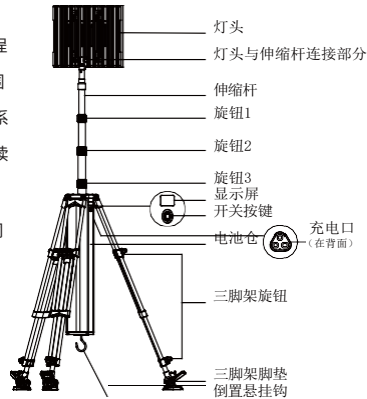

主要参数

尺寸	φ0.22 米 x 1.02 米		高度	最大	3.8 米
重量	13 千克			最小	1.02 米
亮度	极亮档	200W	22000 流明	极亮档	3 小时
	高亮档	75W	10000 流明	高亮档	8 小时
	中亮档	33W	5500 流明	中亮档	18 小时
	低亮档	15W	2000 流明	低亮档	40 小时
电池容量	600Wh (48×18650 锂电池, 3400mAh)		电池电压	11.1V	
充电时间	8 小时		灯具防护等级	IP66	
充电器	输入 AC 100 ~ 240V 输出 DC 15V/19A		充电器防护等级	IP67	

注：不同使用环境可能会对以上数据产生影响。

布置 FLS360

1. 将 FLS360 垂直放置在平坦的地面上，并解开尼龙便携袋，如图 (1)。
2. 调整灯头。灯头由 3 块灯板组成，灯板间角度可灵活调节 (定向或 360° 方向照明)，如图 (2)。
灯头与伸缩杆连接位置可旋转调节灯头俯仰角度，如图 (3)。

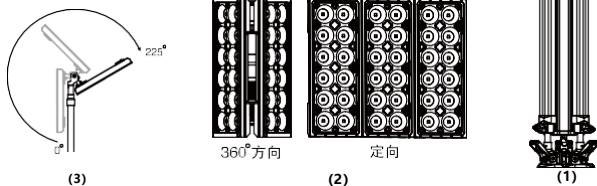

3. 用户可根据实际使用需要装上柔光片。柔光片可直接通过磁吸附着在灯板表面。

4. 展开三脚架。脚管的末端各有 1 个旋钮，按逆时针方向扭松，伸展脚管至所需长度后按顺时针方向扭紧。展开脚管后，可使用地钉将 FLS360 固定在地面上增强稳定性，如图 (4) (5)。脚管末端设有可拆卸活动脚垫，可根据地势调整角度。拆卸脚垫后可直接把脚管插入沙地或土质松软的地面上使用，如图 (6)。

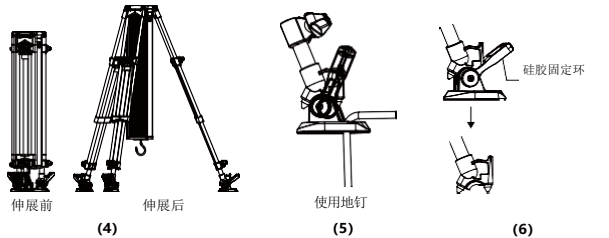

5. 调节伸缩杆长度。伸缩杆上有 3 个旋钮，先按逆时针方向扭松旋钮 1，调节伸缩杆长度后按顺时针方向扭紧。若仍未达到所需长度，再以相同方式，依次扭松旋钮 2 及旋钮 3 进行调节。

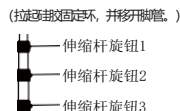

6. 电池仓下方设有倒置悬挂钩，遇上大风天气时，可挂上沙袋 (重量不得超过 5kg) 以加强支架稳定性。

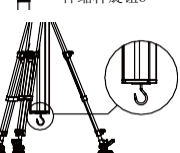

开启 / 关闭

开启：在关闭状态下，短按开关按钮即开启低亮档，此时显示屏会显示当前档位及流明值，约 2 秒后显示电池电压、续航时间及电池剩余电量。位于开关按钮的蓝色提示灯会长亮。**关闭：**在开启状态下，长按开关按钮即关闭照明，此时显示屏会显示电池电压及电池剩余电量，约 10 秒后熄灭。蓝色提示灯会慢闪提示用户。

警告：

1. 使用环境温度：-20°C ~ 60°C，当使用环境温度低于 -20°C 时，须在常温环境下放置半小时后再使用。
2. FLS360 开启时灯头温度较高，请至少与灯头保持半米距离。
3. 长时间开启 FLS360 后，请勿触摸灯头以防烫伤。使用完毕，必须等灯头温度降低后再收起。
4. 请勿直视光源，以免对眼睛造成损害。
5. 未成年人必须在成人监督下使用。

亮度调节

开启 FLS360 即进入低亮档，每次短按开关，将按“低亮档 - 中亮档 - 高亮档 - 极亮档”顺序循环切换。

锁定及解锁

在关闭状态下，长按开关按钮超过 2 秒即进入锁定状态，此时蓝色指示灯不再闪烁。在锁定状态下，几乎不会消耗电池电量，且开关按钮处于锁定状态以防止误触开启。如在锁定后短按开关，蓝色提示灯会亮起，约 2 秒后熄灭。长按开关按钮超过 2 秒即可解除锁定状态。

充电

将 AC 充电器一端接入充电口，另一端接电源插座即可充电。(可选购专用车载充电线充电)

- 当 FLS360 在照明关闭状态下进行充电，最大充电电流为 10A。
- 当 FLS360 在照明开启状态下进行充电，充电电流为 3A。
- 如使用车充充电线对 FLS360 进行充电，充电电流为 3A。此时如开启照明，将不能开启极亮档和高亮档。

注：使用车充充电前，必须先启动车辆。

充电提示

	提示灯	显示屏	
充电中	闪烁	当前电池电压	充电进度条
充电完成	长亮	当前电池电压	电量条满格
充电异常	快速闪烁	"ERROR" 字样	

注：

1. 在不开启照明情况下为电池充电，所需充电时间约为 8 小时。(不同环境及电池健康状况对充电时间会产生影响)
2. 请在环境温度为 0°C ~ 45°C 范围内，对电池进行充电。

保护功能

- 内置电池设有保护电路，可防止电池出现过充、过放、过流及短路情况。
- 当电池电压过低时，FLS360 会自动降档，以保护电池。
- 使用极亮档时，如果其中 1 块灯板因故障熄灭，FLS360 会自动降至高亮档；使用极亮档或高亮档时，如果有 2 块灯板因故障熄灭，会自动降至中亮档。

存放 FLS360

- 关闭 FLS360。
- 关闭后，请放置 10-20 分钟，待灯头部分温度下降后再收起，以免烫伤。
- 收起伸缩杆。抓紧旋钮 3 上方的伸缩杆部分并扭松旋钮 3，缩短伸缩杆后扭紧。以相同方式依次调整旋钮 2 及旋钮 1。
- 收起灯头。调整灯头俯仰角度至 0°，请参考图 (3)。调节 3 块灯板间角度，收起灯板使其面向 360° 方向。
- 收起三脚架。拔出地钉，抓紧伸缩杆部分，扭松脚管旋钮，缩短脚管后扭紧，收起脚管。
- 装入尼龙便携袋。

保养

1. 当长时间储存 FLS360，请每半年为电池充电 5 小时。
2. 请保持灯头部分清洁，以免影响灯板散热及镜片透光度。
3. 请定期检查灯头与伸缩杆之间连接部分，如果太松，可以用扳手适当拧紧转轴螺母。

注意事项

1. 收回灯头、伸缩杆和三脚架时，请注意不要夹伤手。
2. FLS360 展开后整体高度较高，请评估使用环境，做好防护措施，以防侧翻。
3. 灯头与伸缩杆之间连接部分比较脆弱，搬运时请着力于支架部分，避免只抓住灯头部分搬运。
4. 将 FLS360 装入收纳前，请长按开关锁定，以防误触开启。
5. 在雨天 (甚至暴雨) 环境下，不影响使用。
6. 请勿让电池仓及以上部分浸泡在水中。

保固

NITECORE® 产品拥有售后保固服务。在购买本产品的 12 个月内享受免费保固服务。在超过 12 个月免费保固期后，本产品享有终身有限度保固服务，如需要更换重要部件则需收取成本费用。

本保固规则不适用于以下情况：

1. 人为破坏，拆解，改装本产品。

2. 错误操作导致产品损坏。

如对奈特科尔产品有任何疑问，欢迎联系当地的代理商或发邮件到 4008869828@nitecore.cn

※ 本说明书的所有图片、陈述及文字信息仅供参考，请以官网 www.nitecore.cn 实际信息为准。思迈工贸有限公司拥有对说明书内容的最终解释权及修改权。

SYSMAX Ind.

思迈工贸有限公司
咨询热线：+86-20-83862000
销售邮箱：info@nitecore.com
网址：www.nitecore.cn
大陆办事处地址：中国广东省广州市天河区洗村路 5 号凯华国际中心 2601-06 室
邮编：510623

更多相关信息请关注新浪微博：NITECORE 奈特科尔



400 客户服务热线：400-886-9828 感谢您购买我们的产品！